

CABLE ASSEMBLY



COSLAND CO., LTD.

Website: www.cosland.com

E-Mail: cosland@cosland.com

Tel No.: (02)2745 8908, 2745 8909.

Fax No.: 886-2-2765 3456.

No.6, Alley 30, Lane 59, Sec. 5. Nan King East Rd., Taipei, Taiwan.

COSLAND CO., LTD.

USB AM TO AM

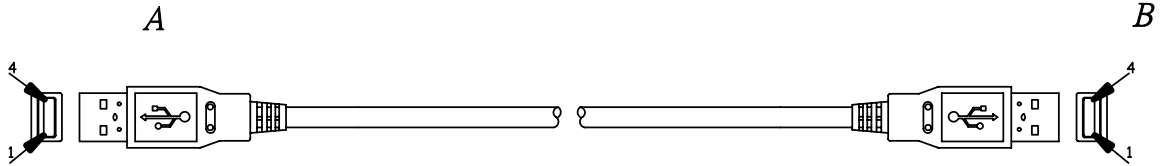

PIN ASSIGNMENT

A	WIRE COLOR	B
1	RED	1
2	WHITE	2
3	GREEN	3
4	BLACK	4
SHELL	DRAIN+BRAID	SHELL

USB BM TO BM

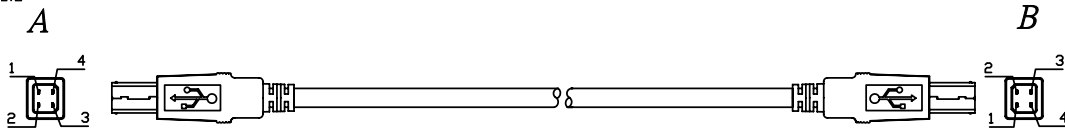

PIN ASSIGNMENT

A	WIRE COLOR	B
1	RED	1
2	WHITE	2
3	GREEN	3
4	BLACK	4
SHELL	DRAIN+BRAID	SHELL

USB AM TO MINI USB 4P

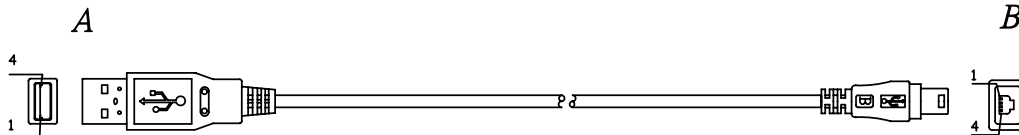

PIN ASSIGNMENT

A	WIRE COLOR	B
1	RED	1
2	WHITE	2
3	GREEN	3
4	BLACK	4
SHELL	DRAIN+BRAID	SHELL

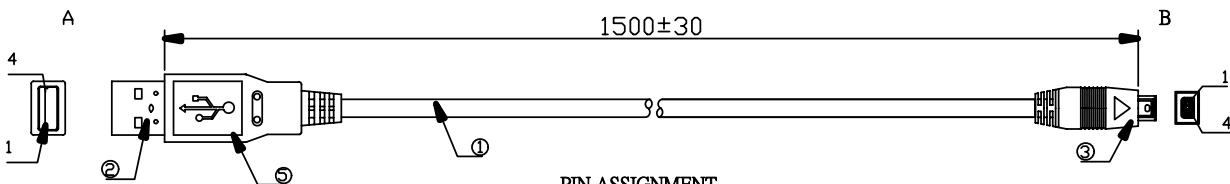

PIN ASSIGNMENT

A	WIRE COLOR	B
1	RED	1
2	WHITE	2
3	GREEN	3
4	BLACK	4
SHELL	DRAIN+BRAID	SHELL

COSLAND CO., LTD.

USB AM TO AF

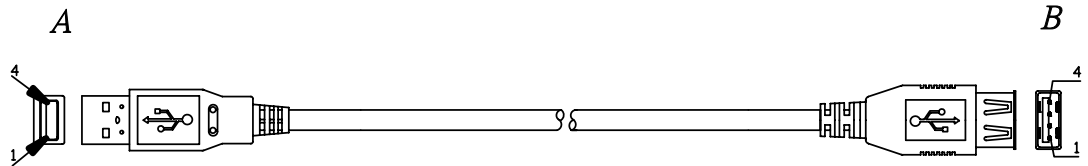

PIN ASSIGNMENT

A	WIRE COLOR	B
1	RED	1
2	WHITE	2
3	GREEN	3
4	BLACK	4
SHELL	DRAIN+BRAID	SHELL

USB AM TO BM

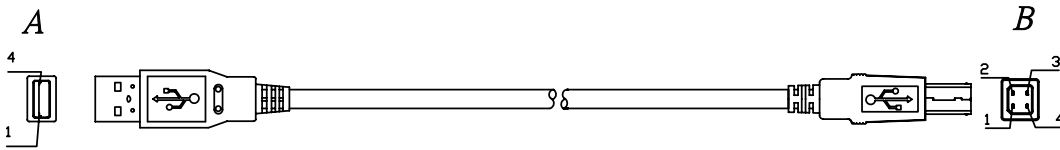

PIN ASSIGNMENT

A	WIRE COLOR	B
1	RED	1
2	WHITE	2
3	GREEN	3
4	BLACK	4
SHELL	DRAIN+BRAID	SHELL

USB AM TO MINI USB5P

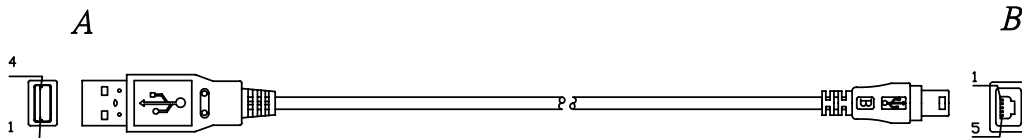

PIN ASSIGNMENT

A	WIRE COLOR	B
1	RED	1
2	WHITE	2
3	GREEN	3
4	BLACK	5
SHELL	DRAIN+BRAID	SHELL

USB AM TO 1.25 5PHS

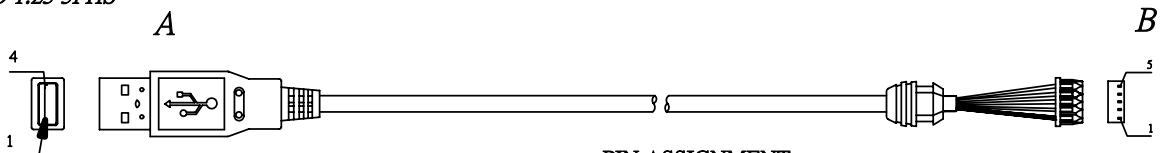

PIN ASSIGNMENT

A	WIRE COLOR	B
1	RED	5
2	GREEN	4
3	WHITE	3
4	BLACK	2
SHELL	DRAIN+BRAID	1

Please visit <http://www.cosland.com> for more detail.

COSLAND CO., LTD.

IEEE1394 6P M TO 4P M

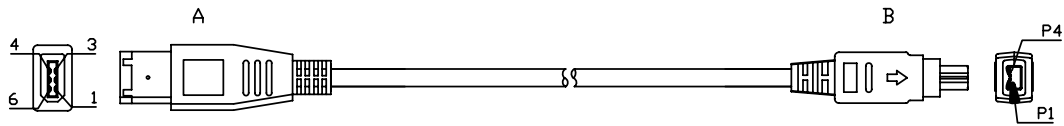

PIN ASSIGNMENT

A		B
1	(Blue)	1
2	(Orange)	3
5	(Red)	4
6	(Green)	2
S	(Drain)	S

IEEE1394 6P M TO M

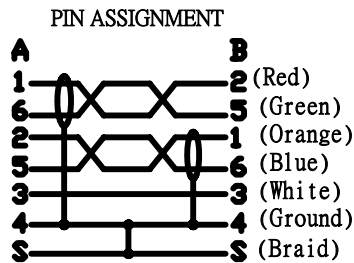
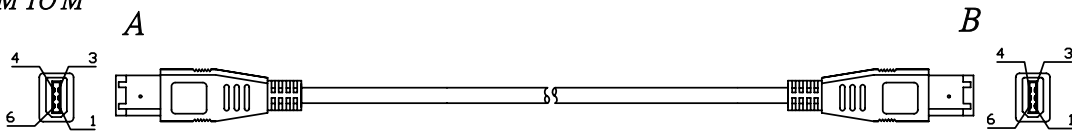

IEEE1394 6P M TO 4P M+2CORE

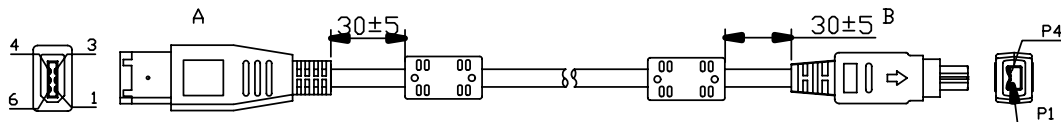

PIN ASSIGNMENT

A		B
1	(Blue)	1
2	(Orange)	3
5	(Red)	4
6	(Green)	2
S	(Drain)	S

IEEE1394 6P M TO M + 2 CORE

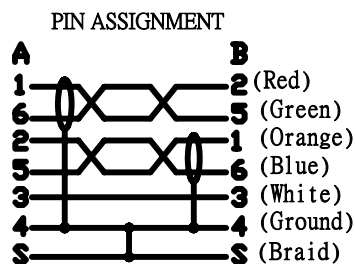
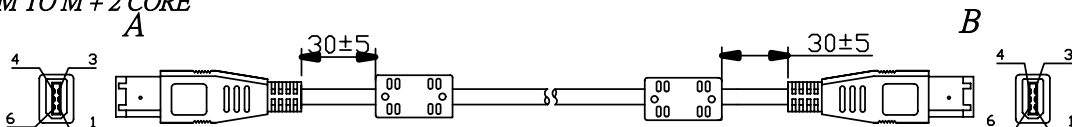

Please visit <http://www.cosland.com> for more detail.

1394B Plug to 1394B Plug

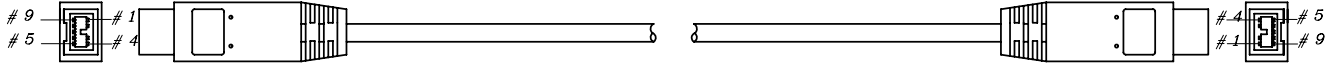

1394B Plug to 1394 Plug

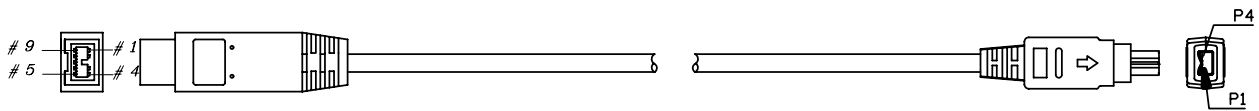

1394B Plug to 1394 Plug

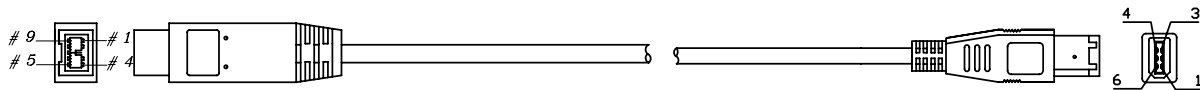

1394B Plug to mini USB

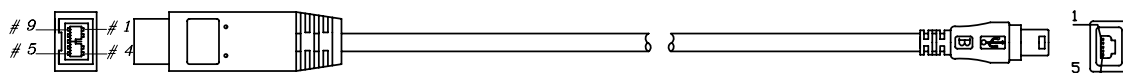

COSLAND CO., LTD.

4P4C TO 4P4C

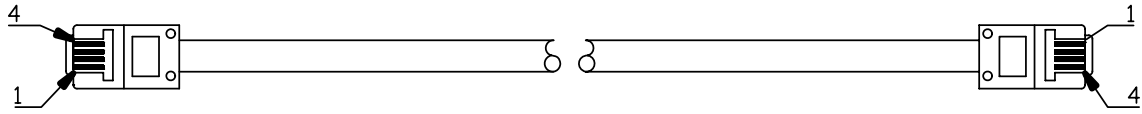

6P6C TO 6P6C

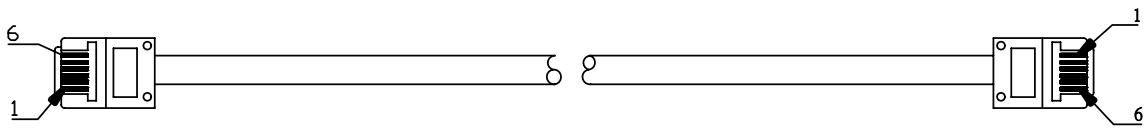

8P8C TO 8P8C

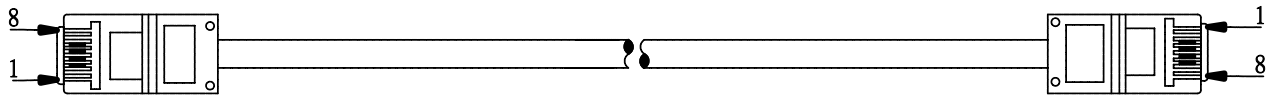

8P8C TO 8P8C (Mold)

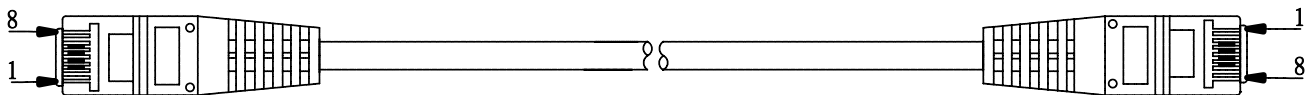

6P4C PLUG TO 6P4C SOCKET.

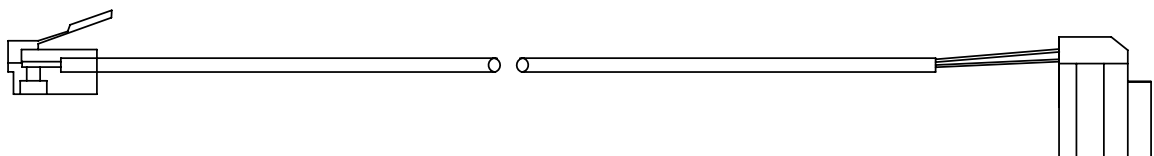

Please visit <http://www.cosland.com> for more detail.

COSLAND CO., LTD.

UTP/STP CAT. 5 (RJ45 TO RJ45)

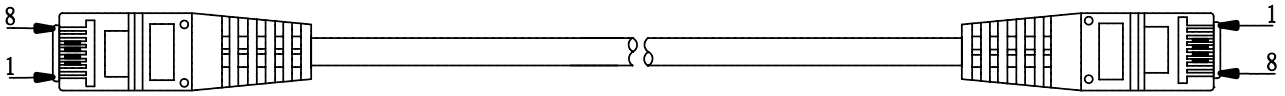

STP CAT.5E. (RJ45 TO RJ45)

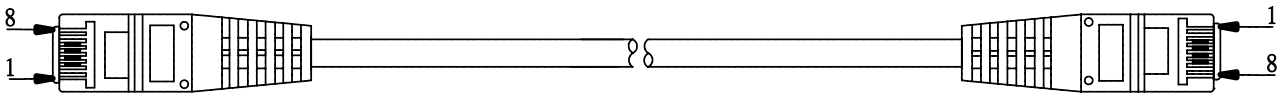

STP CAT. 6 (RJ45 TO RJ45)

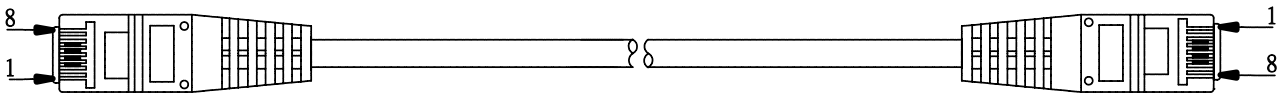

8P8C TO DB9P F

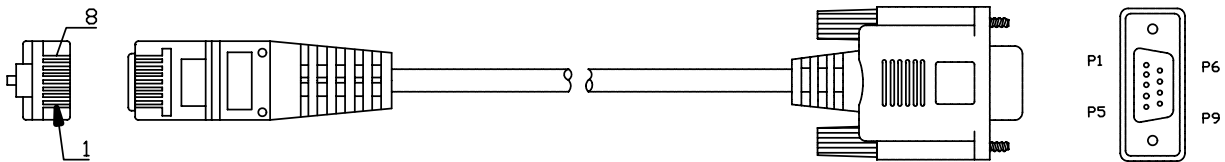

6P6C TO DB15P

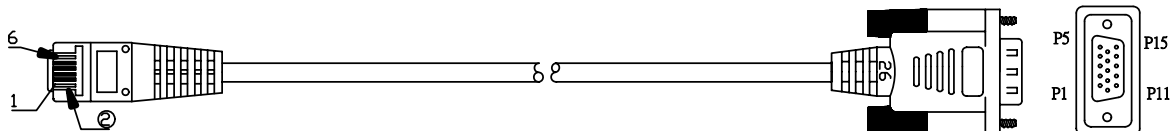

Please visit <http://www.cosland.com>. for more detail.

8P8C TO HD26/S

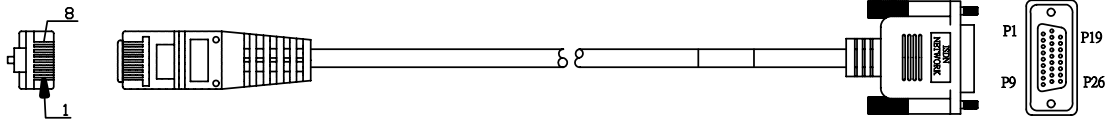

6P6C TO HD15/P

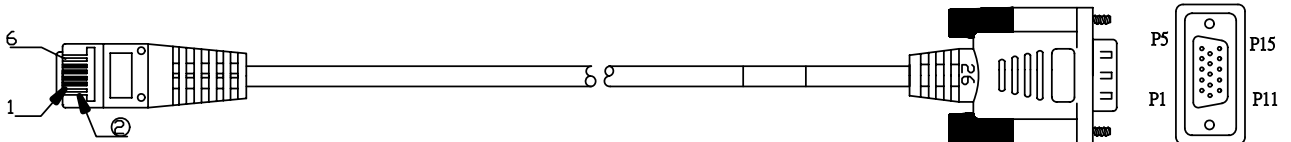

6P6C TO HD26/S

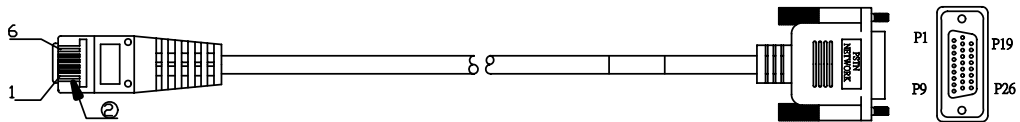

HD15/S TO HD26/S

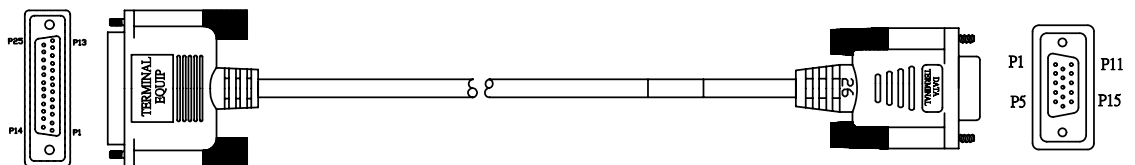

COSLAND CO., LTD.

10P10CTODC M+2R F+2R M

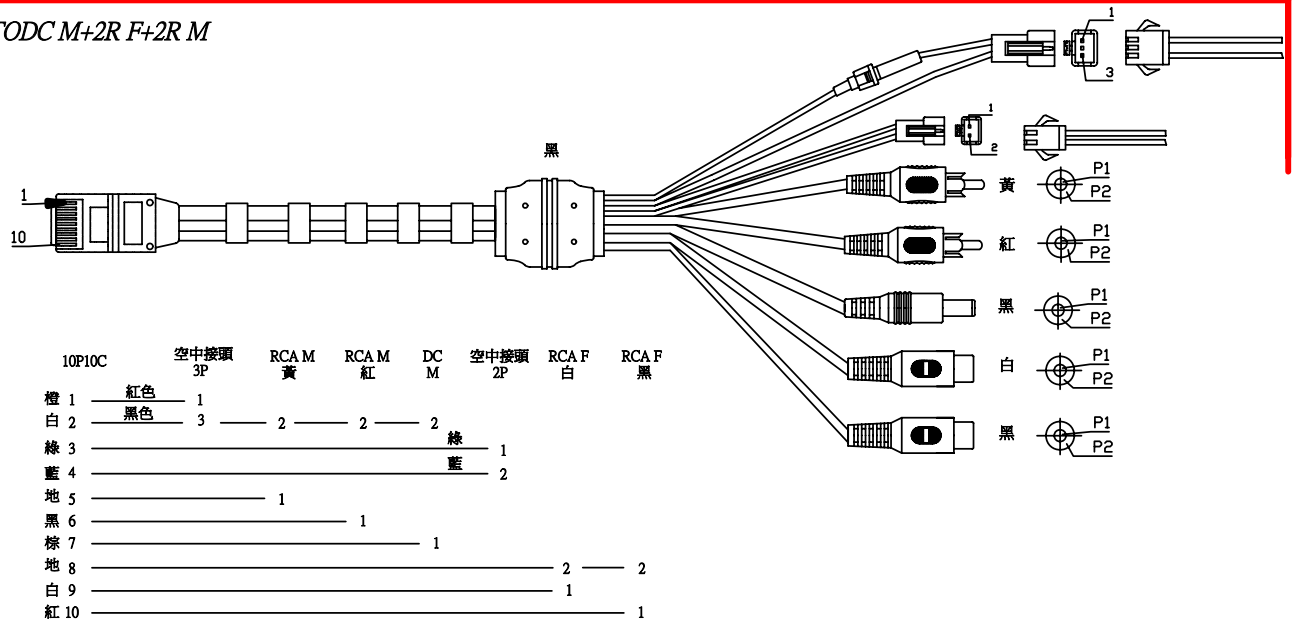

HDB15P MTO8BNC F

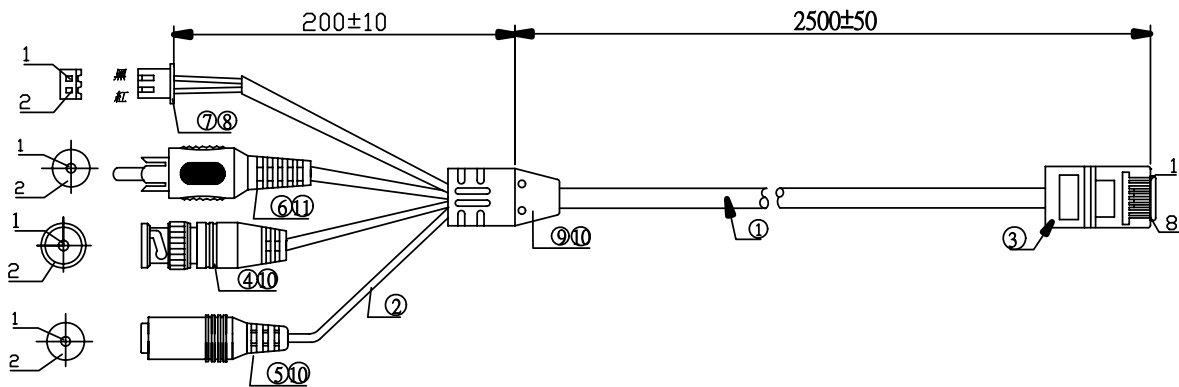
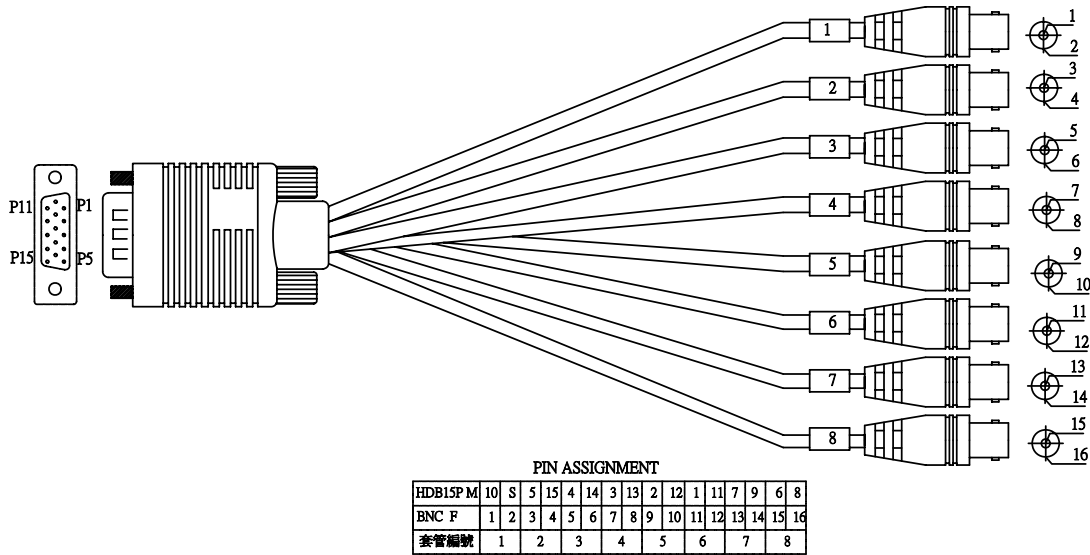

Please visit <http://www.cosland.com> for more detail.

COSLAND CO., LTD.

HDB 15P M TO XH2.5 13PHS+2CORE

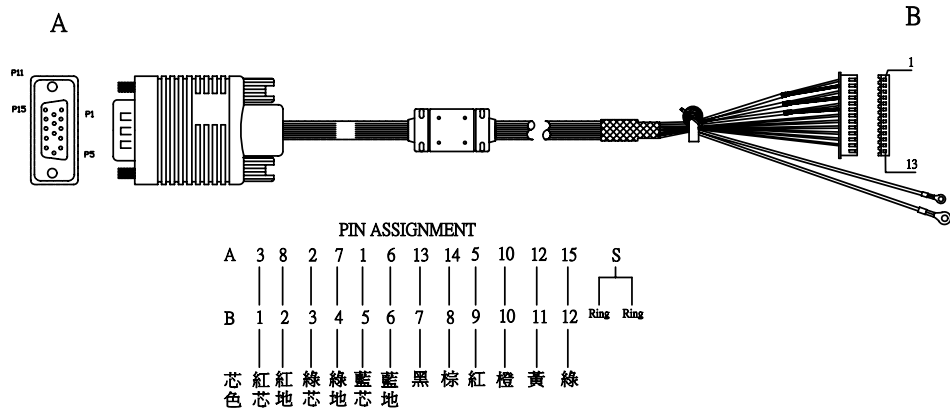

HD15P M TO HD15P

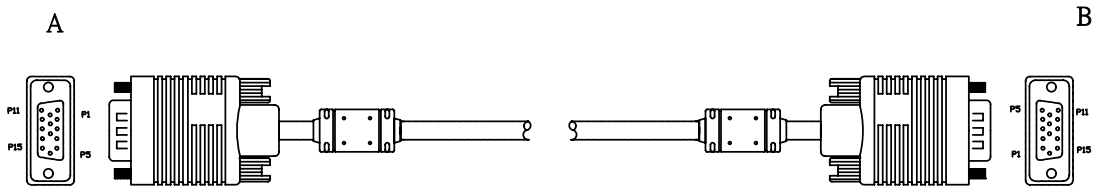

HDB15P M TO HDB15P F

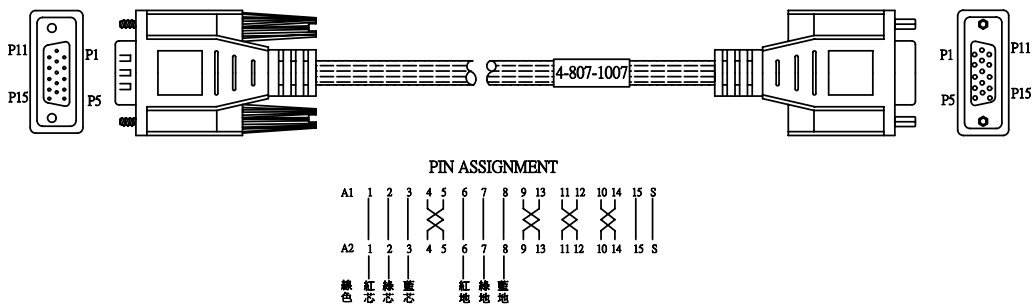

HDB15P M TO DB25P M+2MINI6P M

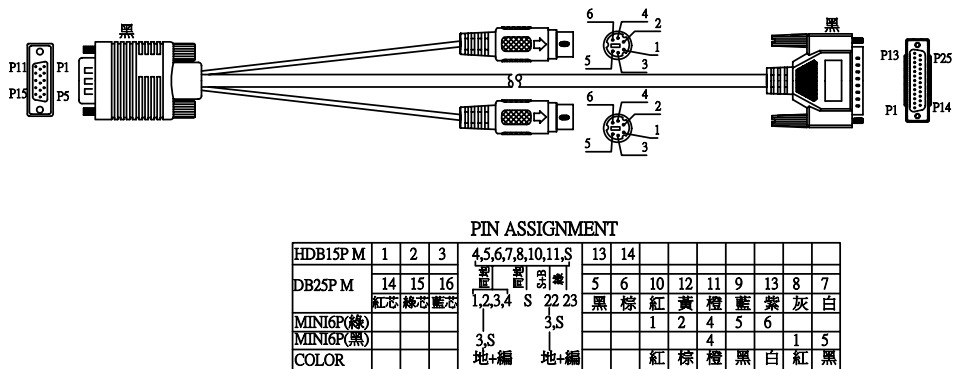

Please visit <http://www.cosland.com> for more detail.

DB9P MTODB9P F

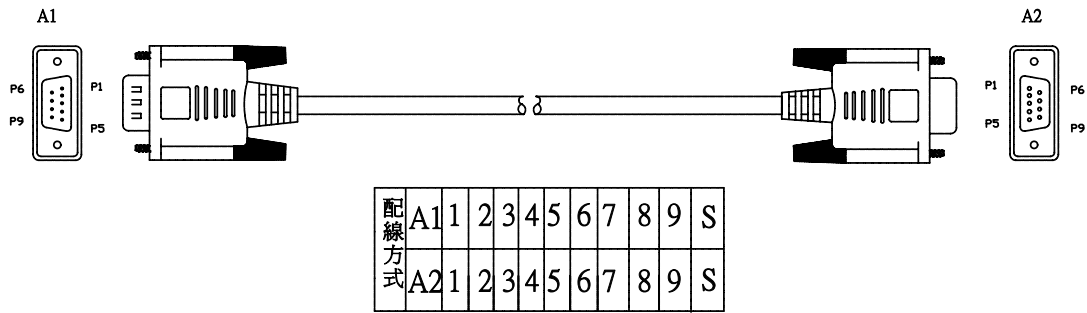

DB15P FTODB9P F+DB9P F

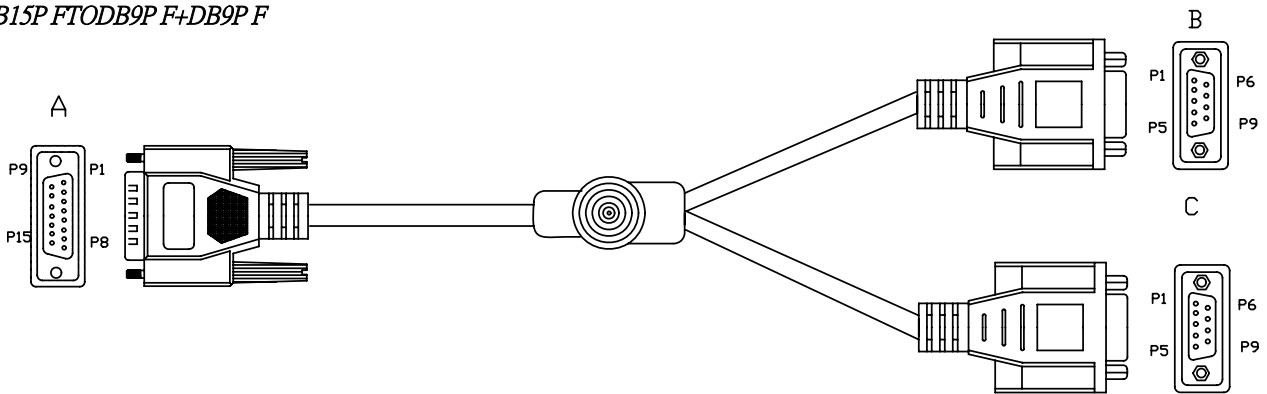

DB9P MTOMD6P M



PIN ASSIGNMENT

DB9P M	MD6P M
7	1
4	3
5	4
2	5
S	S

DB9P F TO Mini 8P

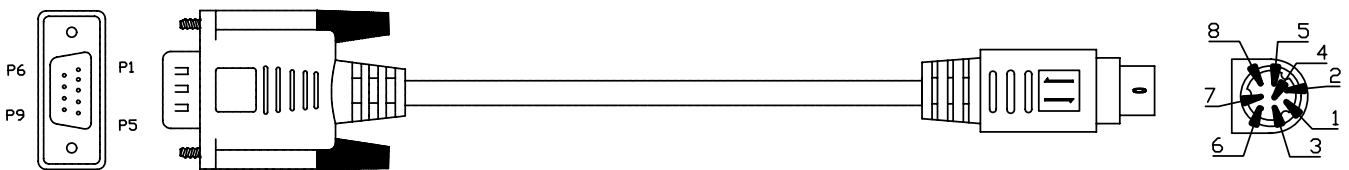

COSLAND CO., LTD.

大D8P MTO4BNC M

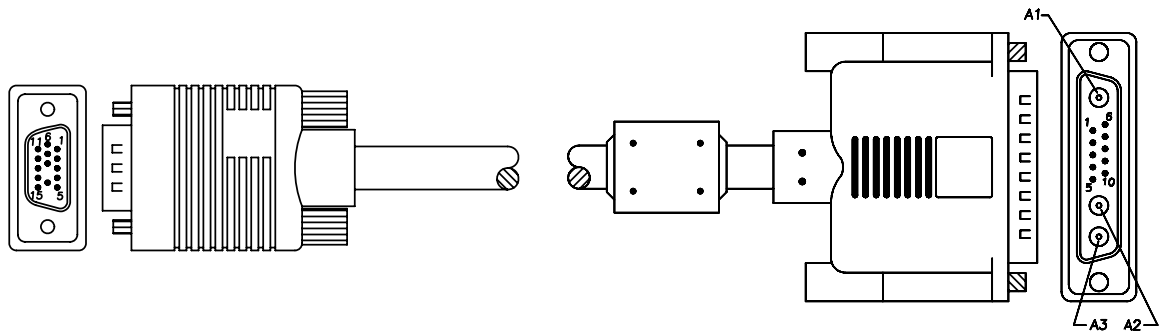
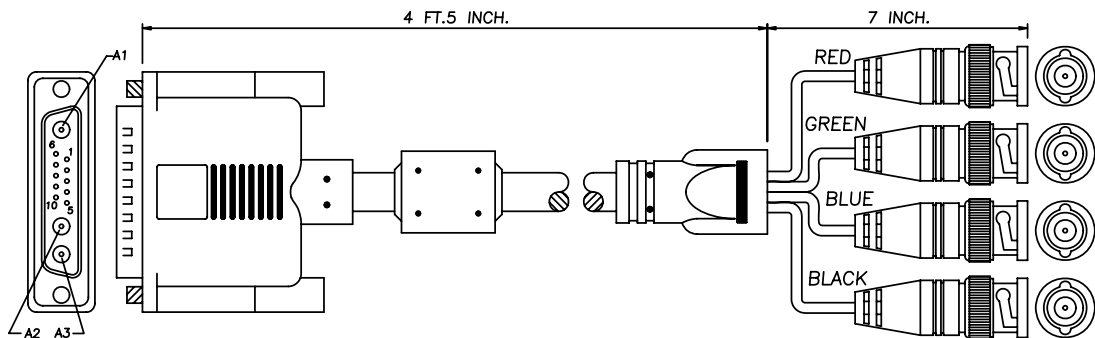
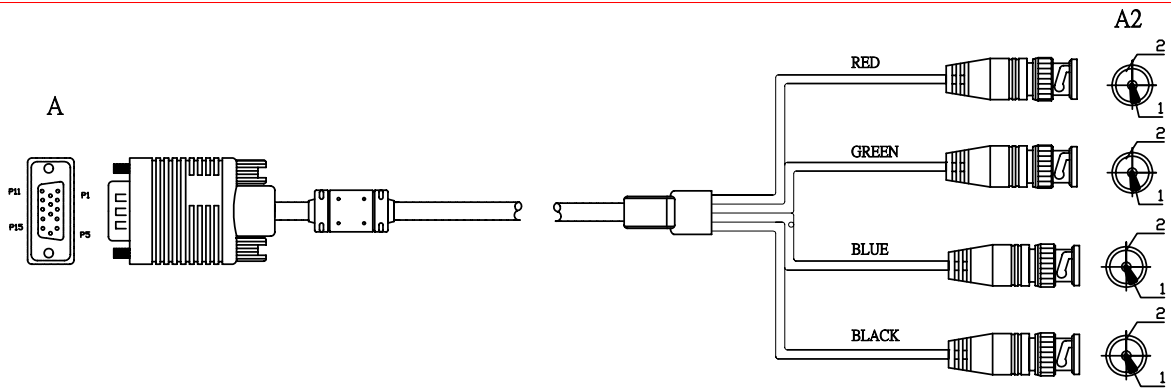
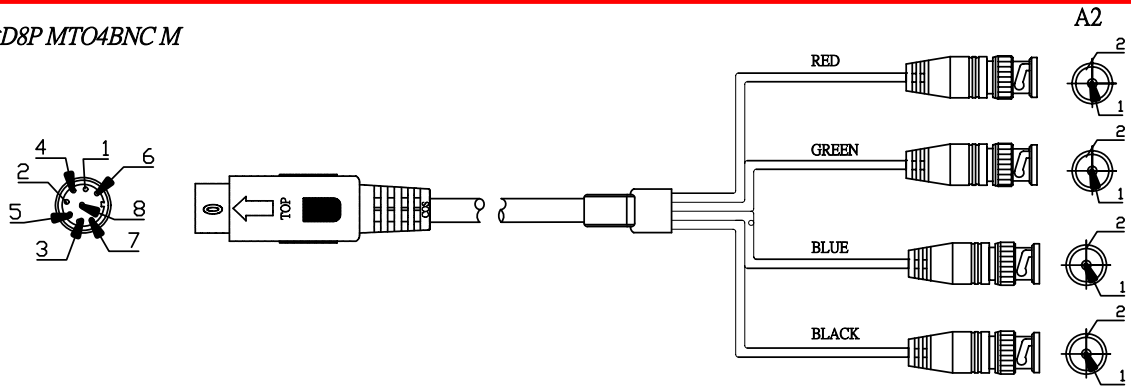

Please visit <http://www.cosland.com> for more detail.

DVI/Male TO DVI/Male

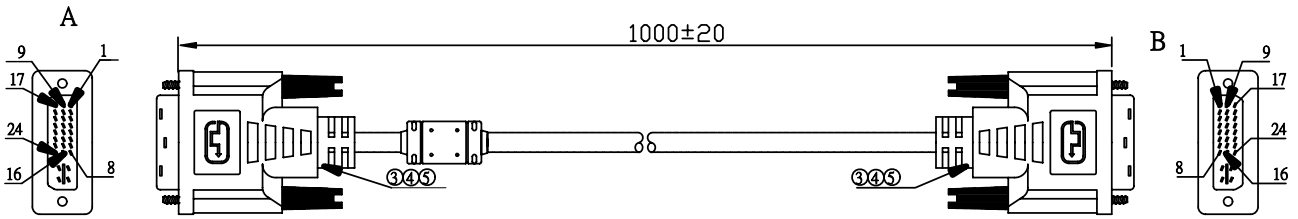

HDMI/Male to DVI/Male

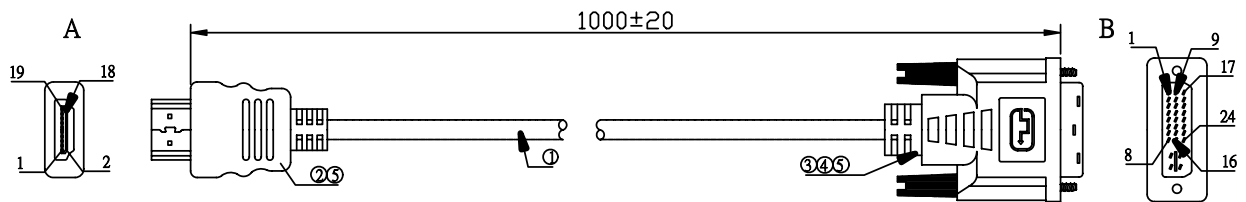

HD-15/M TO DVI/M

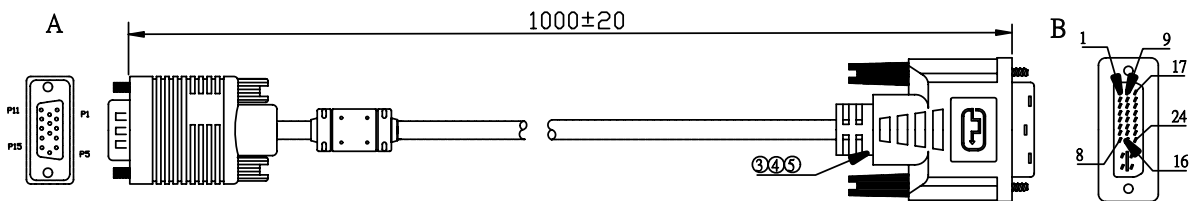

DVI/M TO HD15/F+DVI/F

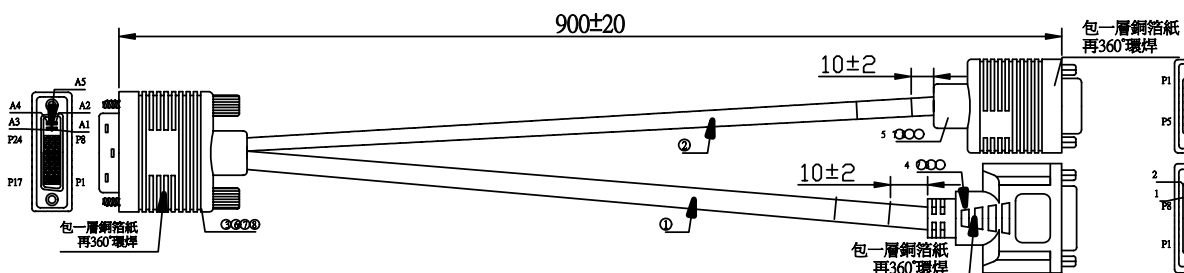

COSLAND CO., LTD.

MINI 8P M TO MINI 4P M+3RCA M

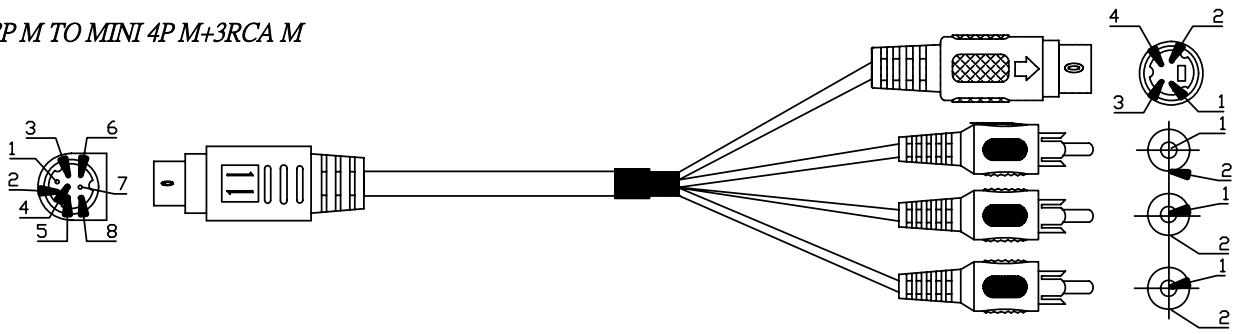

特9P MTOMD4P F+3RCA F

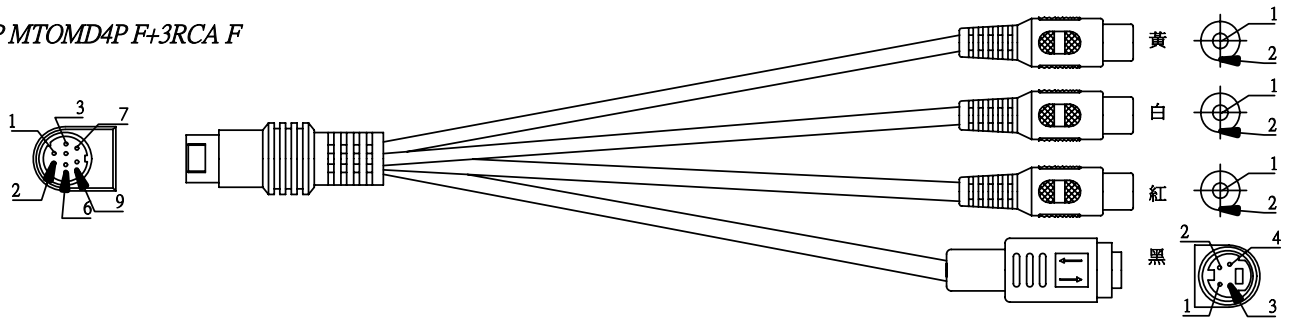

MINI DIN8P M/3RCA M

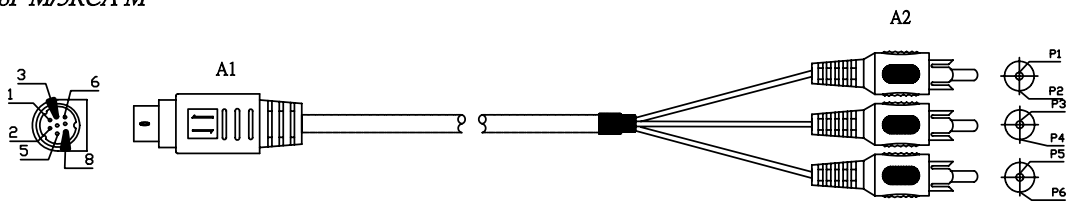

PIN ASSIGNMENT

A1		A2
1	淺綠	1
2	淺綠地	2
3	淺藍	3
4	淺綠地	4
5	紅	5
6	紅地	6

MD6P MTOMD4P F+3RCA F

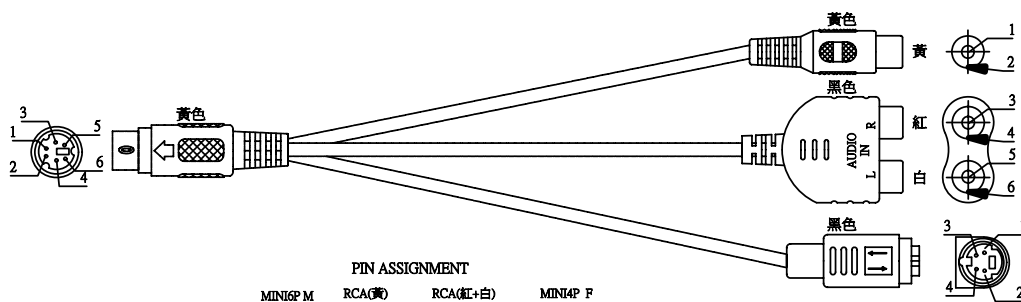

PIN ASSIGNMENT

MINI6P M	RCA(黃)	RCA(紅+白)	MINI4P F
5	1		
3	3		
1	5		
6		3	
4		4	
S	2	4,6	1,2

Please visit <http://www.cosland.com> for more detail.

MINI 6P M TO F

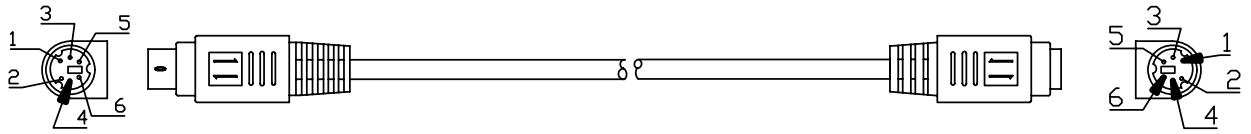

MINI 4P M TO F

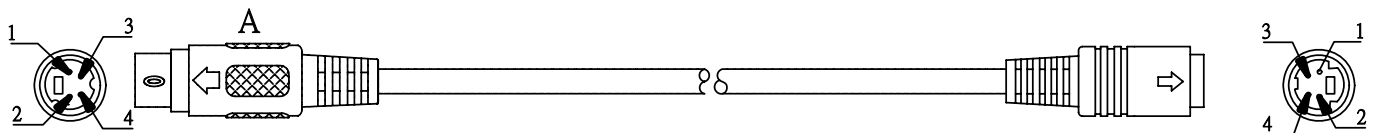

MINI 6P M TO MINI 6P F + DC 頭

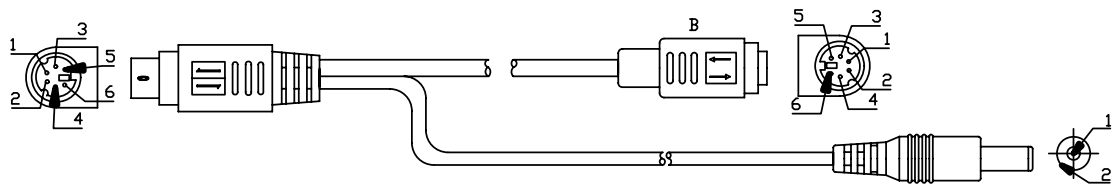

PIN ASSIGNMENT

MINI 6P M	MINI 6P F	DC 頭
4	4	2
3	3	1
S	S	
1	1	
2	2	
5	5	

MINI 6P M TO 2 RCA F

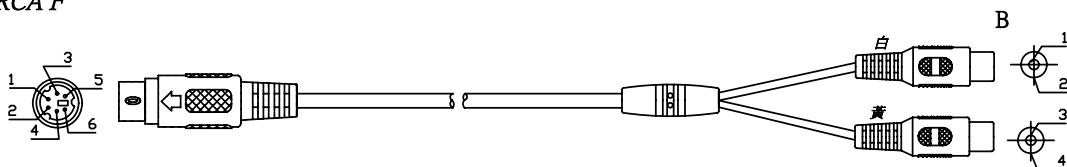

PIN ASSIGNMENT

A		B
3	白	1
6	黃	3
4	白, 黃地	2, 4

MINI 6P MTOBNC M+2*DC M+2PHS+RCA

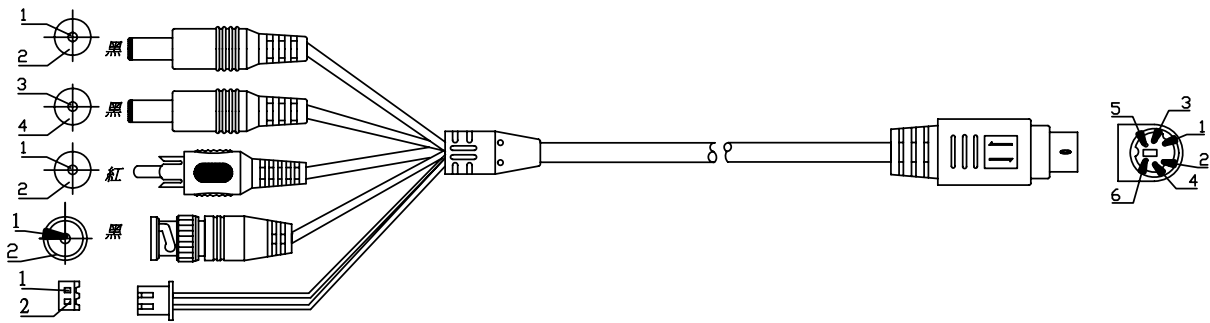

MINI 8P M TO XH2.5 8PHS

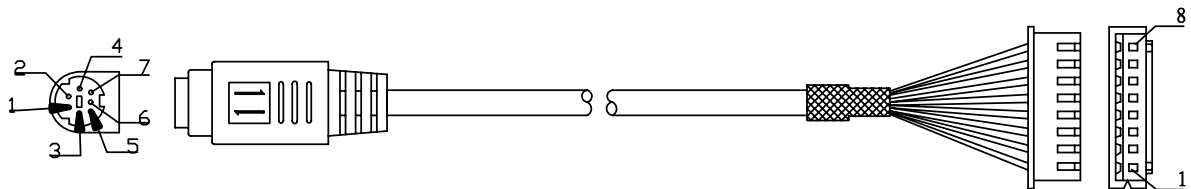

MINI DIN6P MTOJST2.0 7PHS

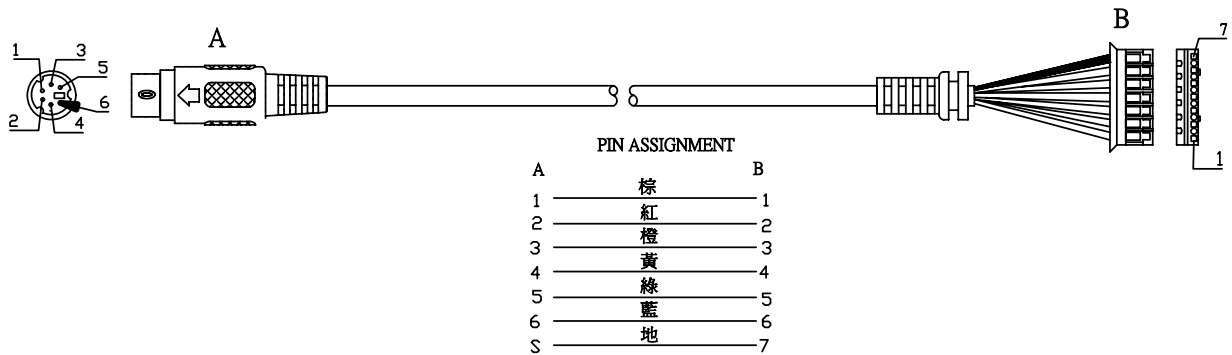

MINI4P M+MTOMOLEX1.25 10 HS

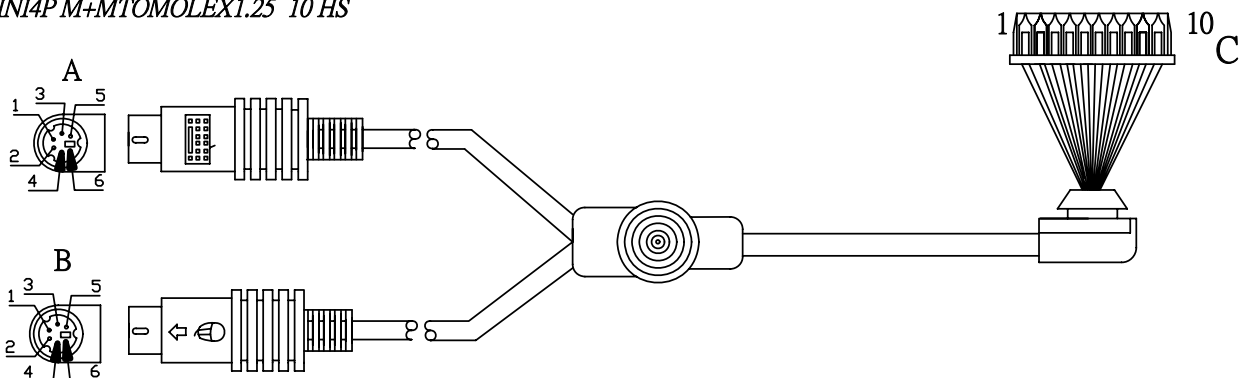

COSLAND CO., LTD.

電鑽頭MTOM

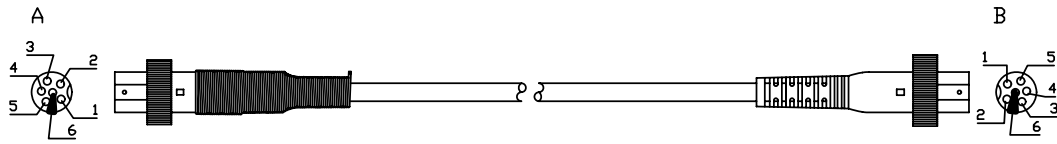

MINI6P MTOF

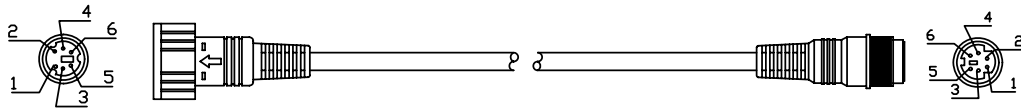

PIN ASSIGNMENT

A	B
1	1
2	2
3	3
4	4
5	5
6	6
S	S

BNC F+DC FTOMINI6P M

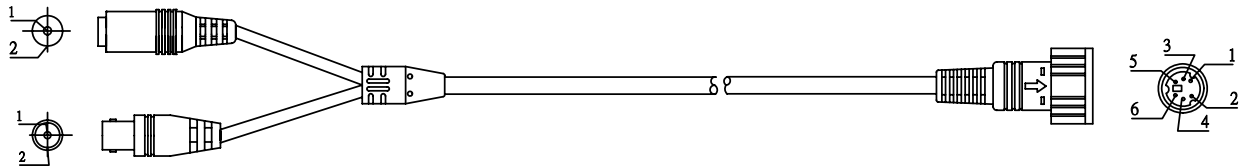

MD6P M+F/DC頭

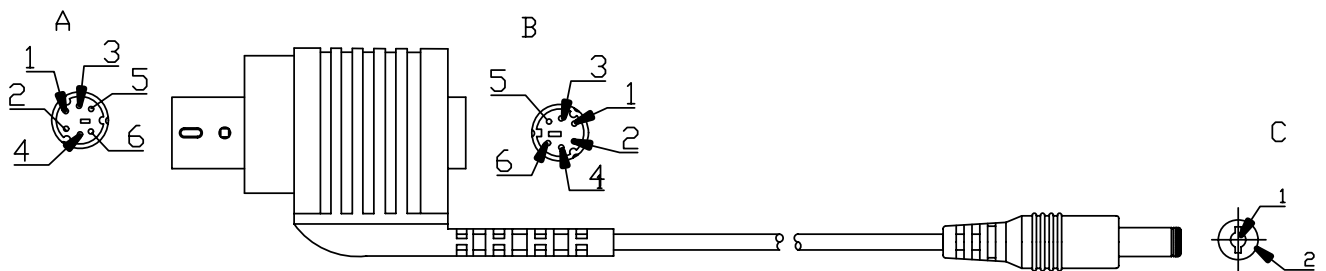

Please visit <http://www.cosland.com>. for more detail.

大D5P(M+F)TODC頭

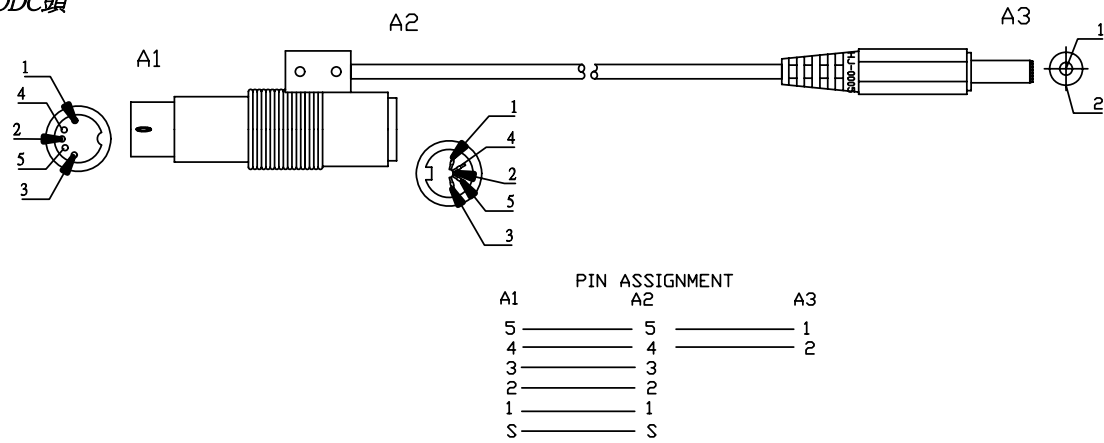

大D8P MTO保險管

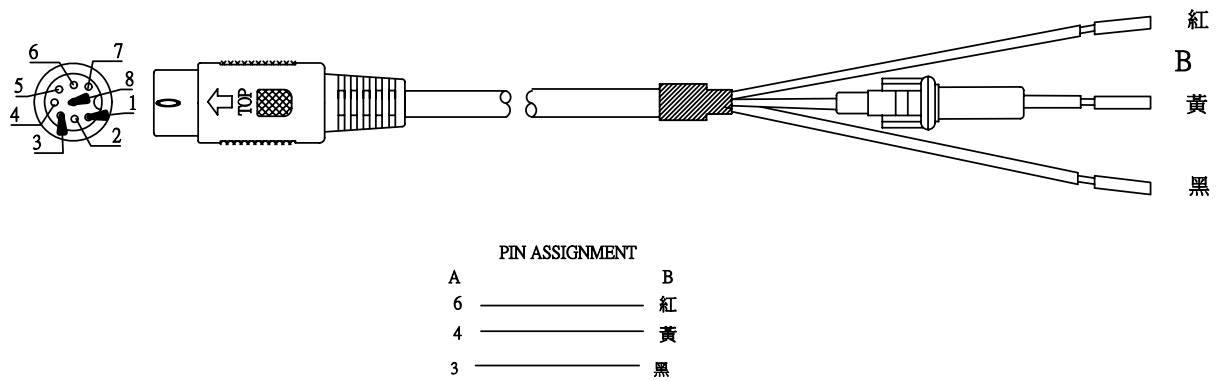

大D5P M TO 大D5P F+MINI 6PM

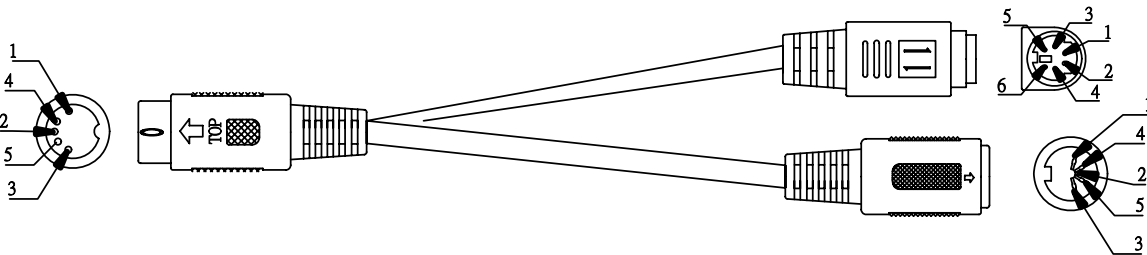

大D5P M TO 尾錫



DIN*2+ RCA*2 TO DB09P

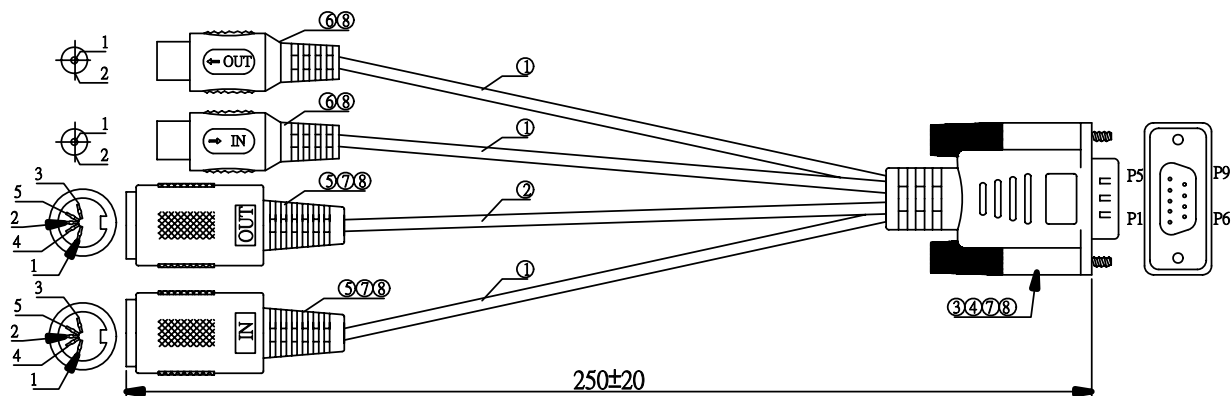

DIN+BNC+RCA TO HD15

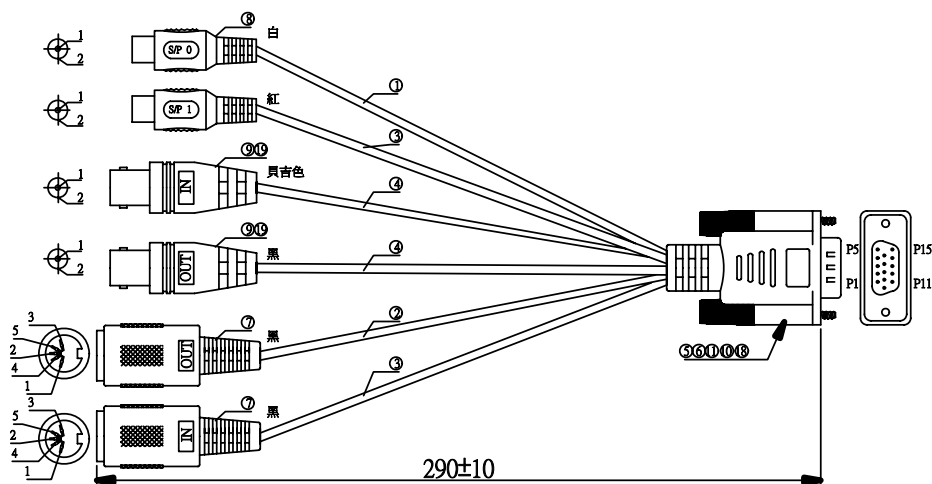

SCART TO RCA+ BNC

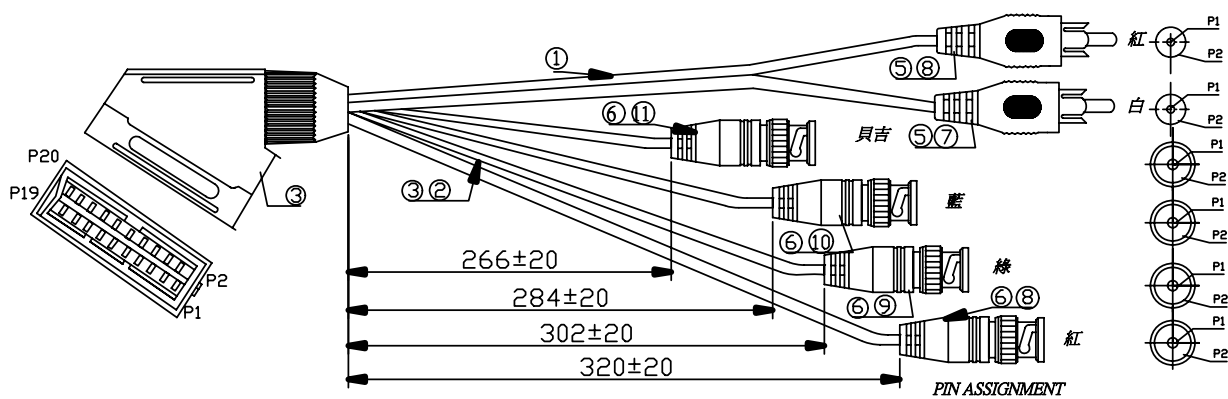

MINI 4P M TO SCART M

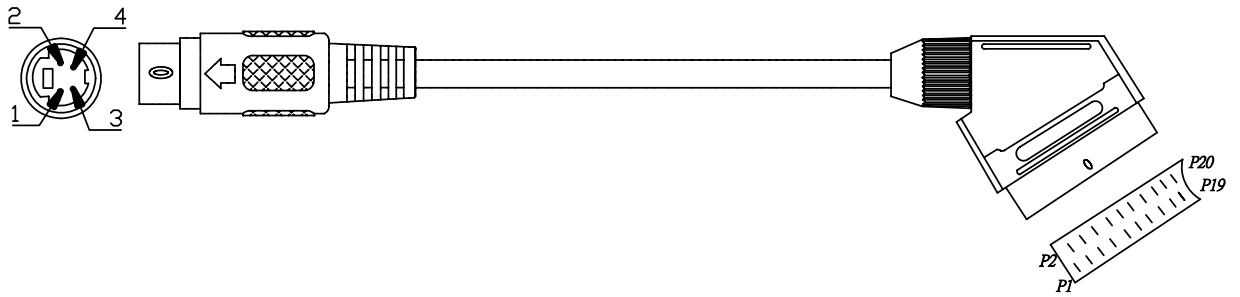

Please visit <http://www.cosland.com>. for more detail.

SCART MTOM

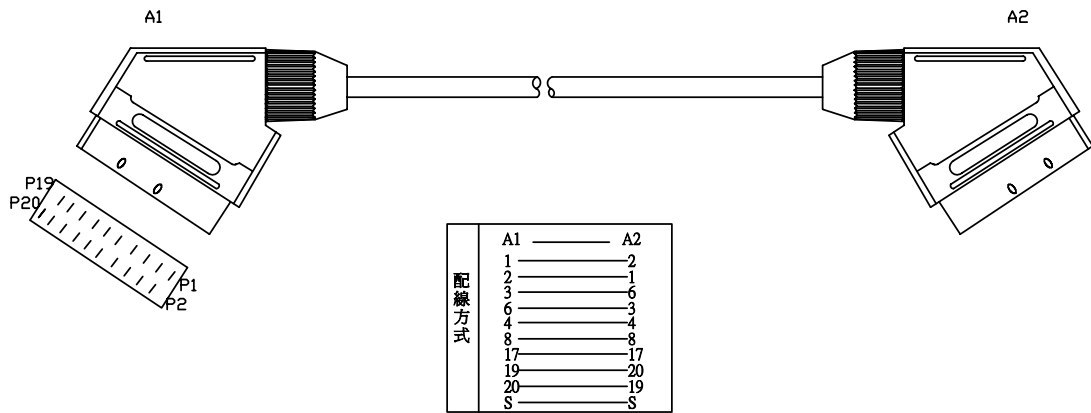

SCART TO 2BNC M+4RCA M

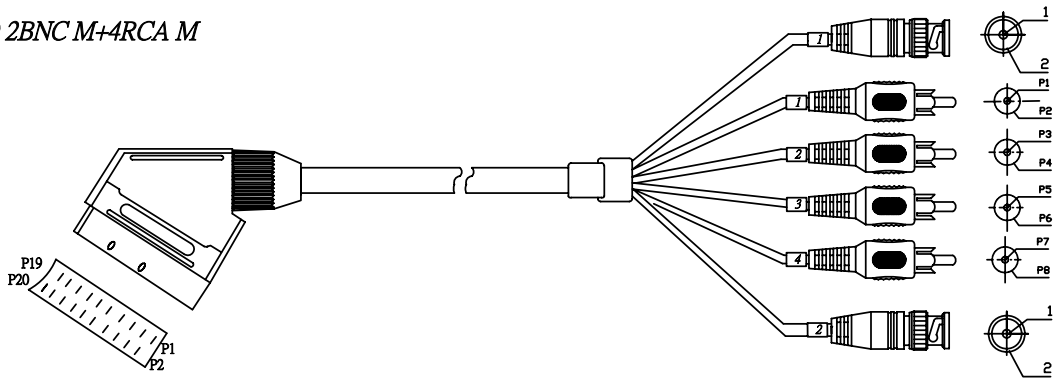

SCART TO HDB15P M+2RCA F_{A1}

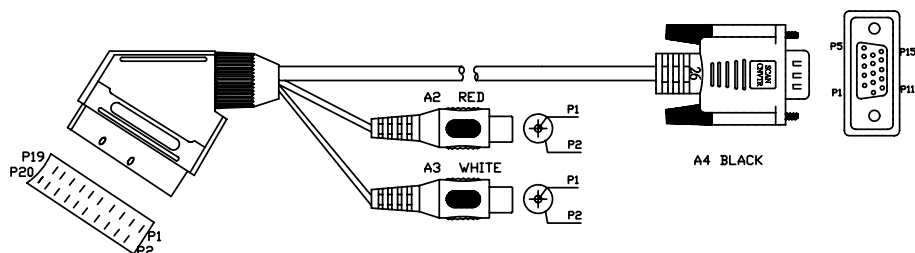

COSLAND CO., LTD.

RGB 12P TO 5RCA+CORE

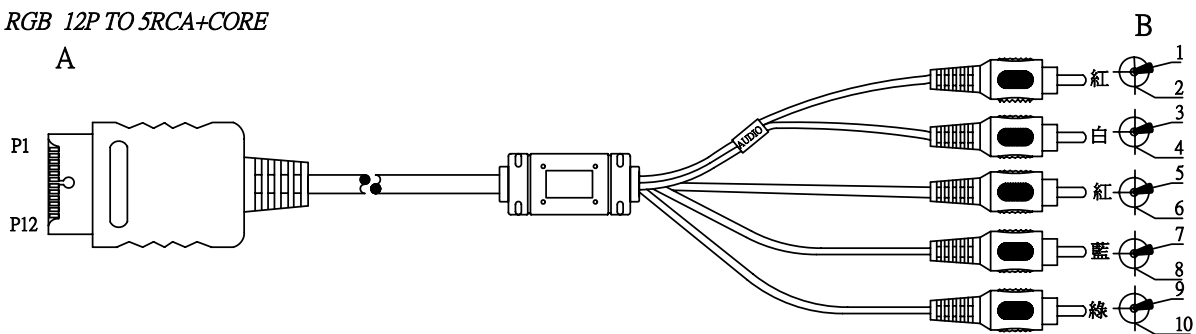

2RCA M TO M

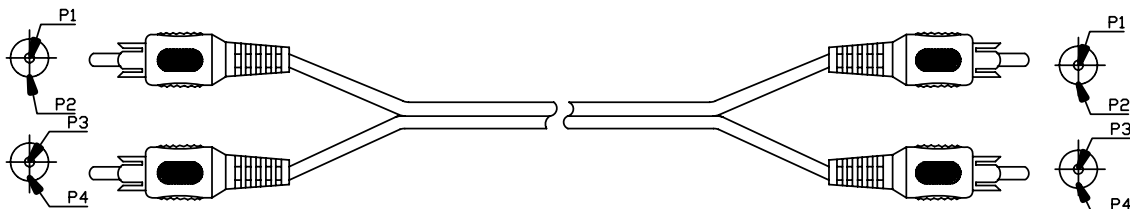

3.5ST FTO2RCA M

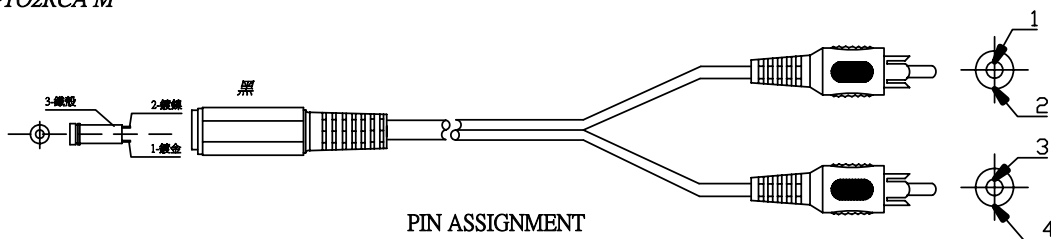

PIN ASSIGNMENT

3.5ST		RCA
1	白	1
2	紅	3
3	白紅地	2,4

3.5ST90° M/2RCA M

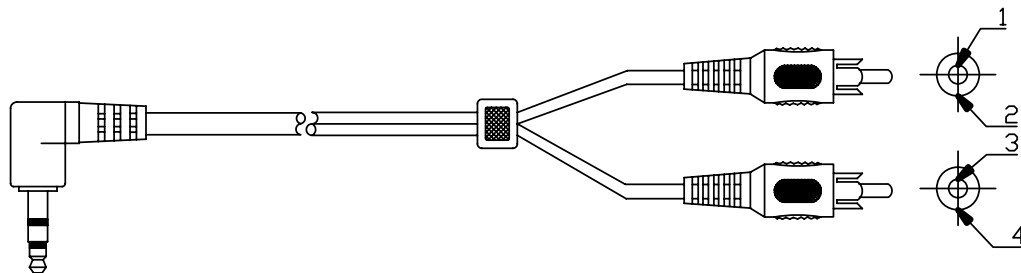

Please visit <http://www.cosland.com> for more detail.

COSLAND CO., LTD.

3.5ST90°TO3RCA M

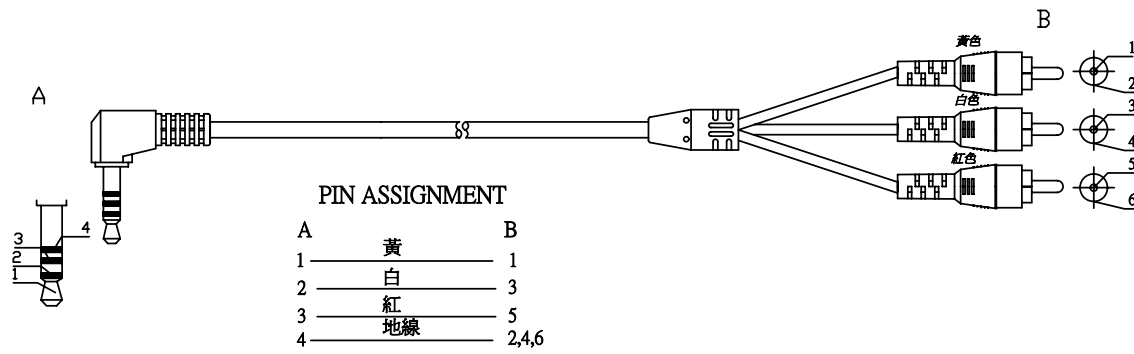

3.5ST M/3.5ST M

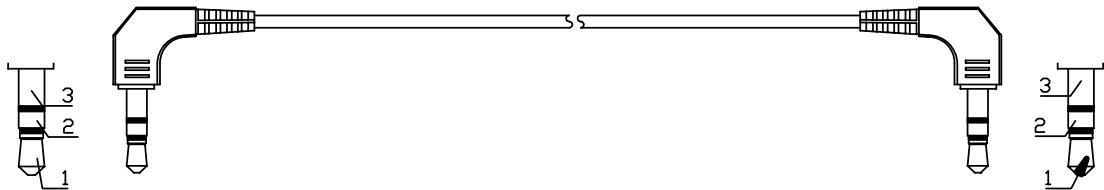

3.5ST M TO F

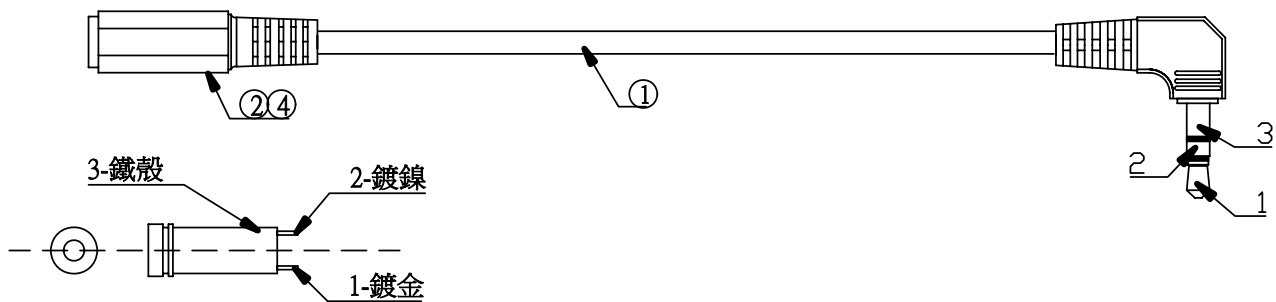

2.5ST TO SENSOR

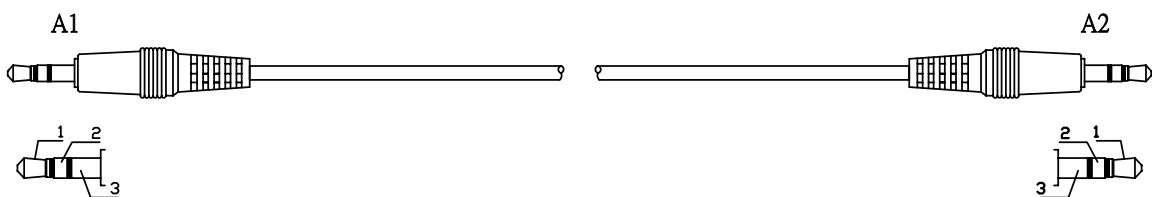

配線方式	A1	白	A2
	P1	—	P1
	P2	紅	P2
	P3	地	P3

Please visit <http://www.cosland.com> for more detail.

3.5ST M TO DB9P F

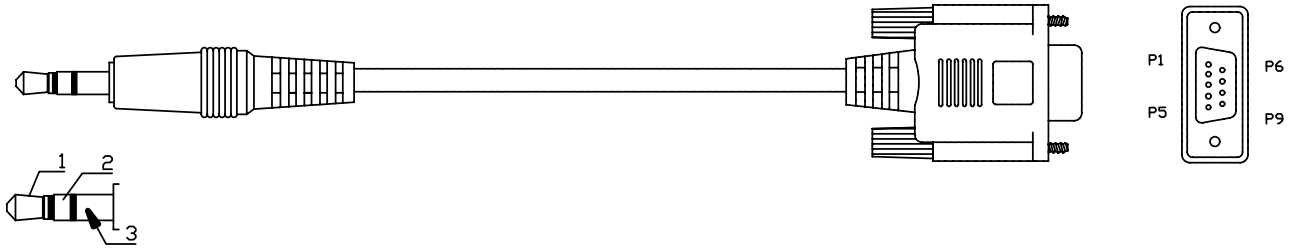

2.5ST TO SENSOR

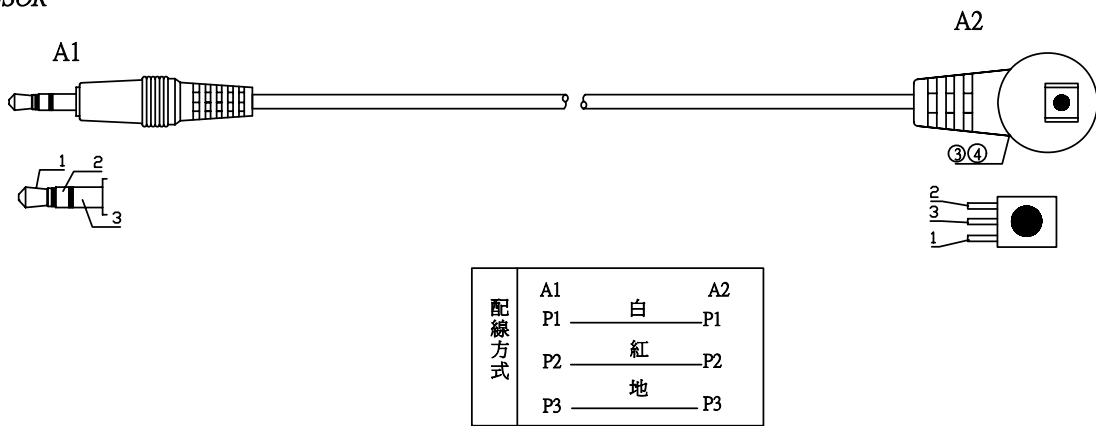

雪茄頭 TO 尾錫

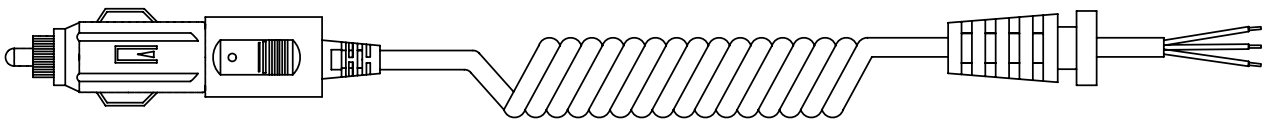

DCM TO 尾錫

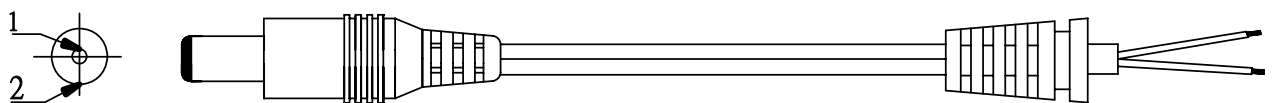

COSLAND CO., LTD.

9.5TV M TO F

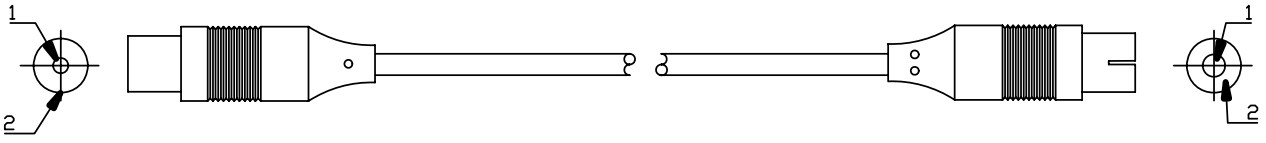

9.5TV M TO F

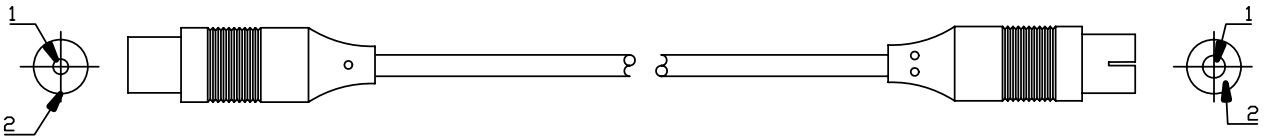

BNC M/M

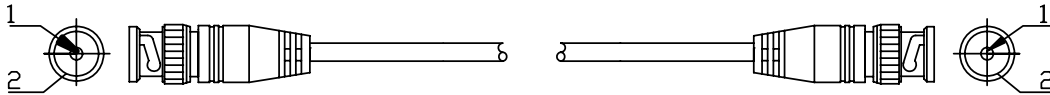

X-BOX 5PTOSAN6P HS

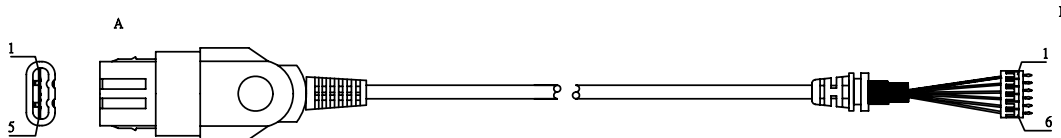

PIN ASSIGNMENT

A	地線	B
S	棕	1
1	紅	2
2	橙	3
3	黃	4
4	綠	5

Please visit <http://www.cosland.com> for more detail.

HD26P TO V.35 Female

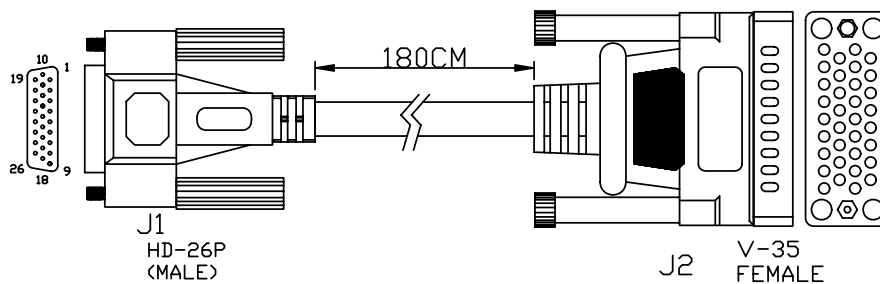

HD26P TO V.35 Male

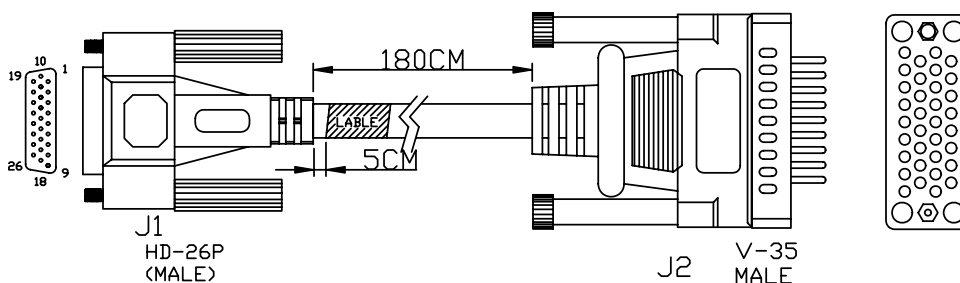

HP26P TO V.35 Female

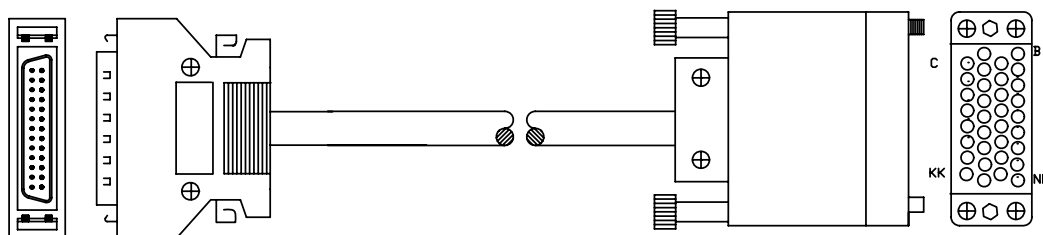

V.35 Male to Female

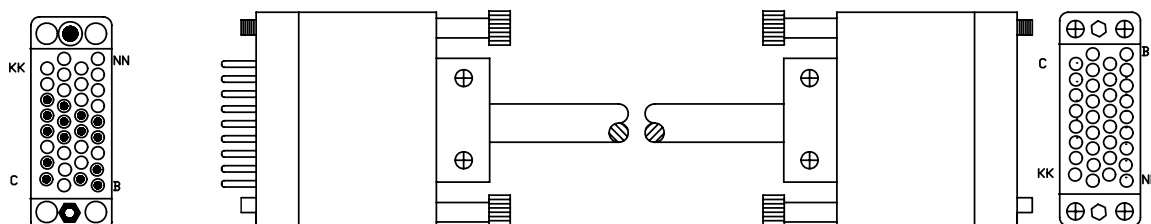

COSLAND CO., LTD.

DB15/Plug TO DB15/Socket.

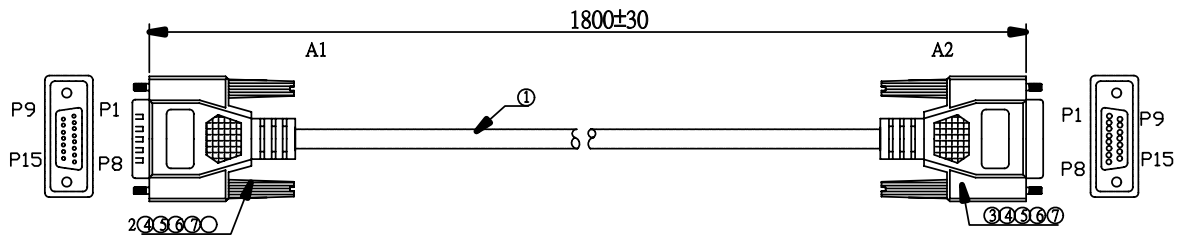

DB25/Plug TO DB25/Plug.

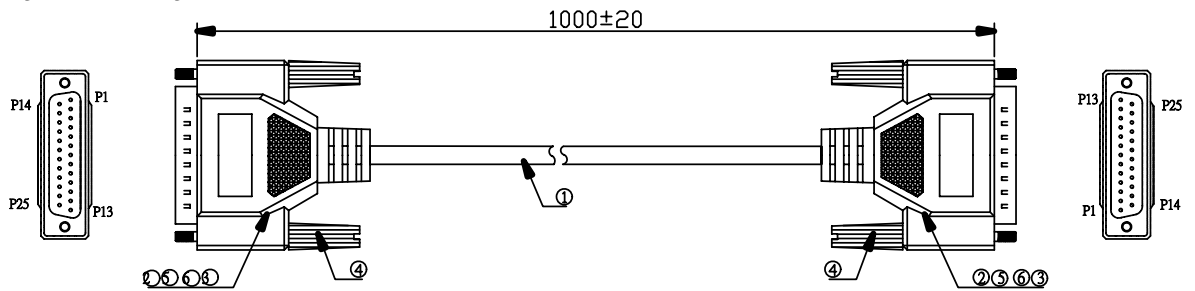

DB25/Plug TO DB9/Socket.

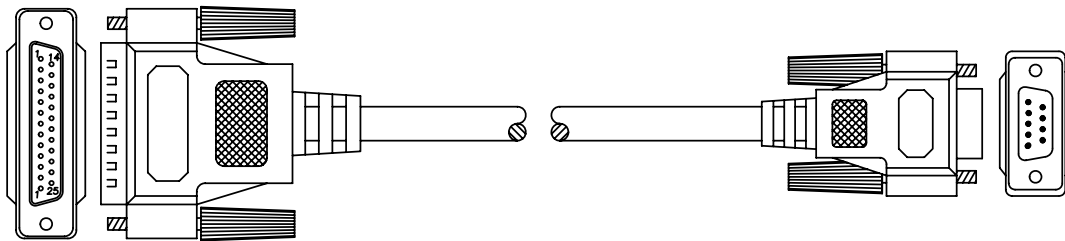

DB25/Plug TO HD26/Plug.

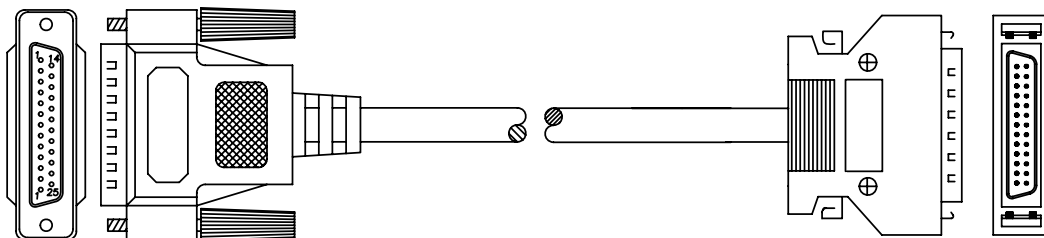

Please visit <http://www.cosland.com> for more detail.

HD26P TO DB25P

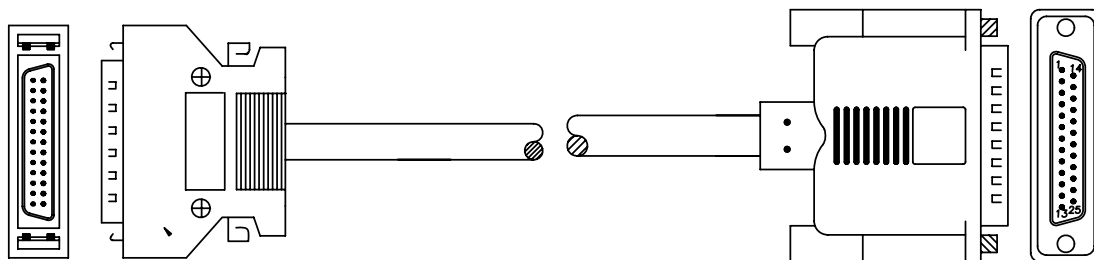

DB78/M TO DB78/M

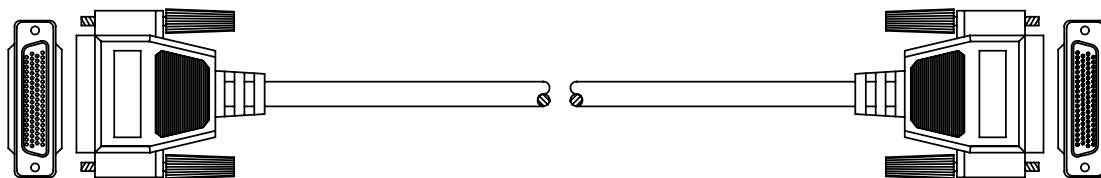

HP50/M TO CEN.50/M

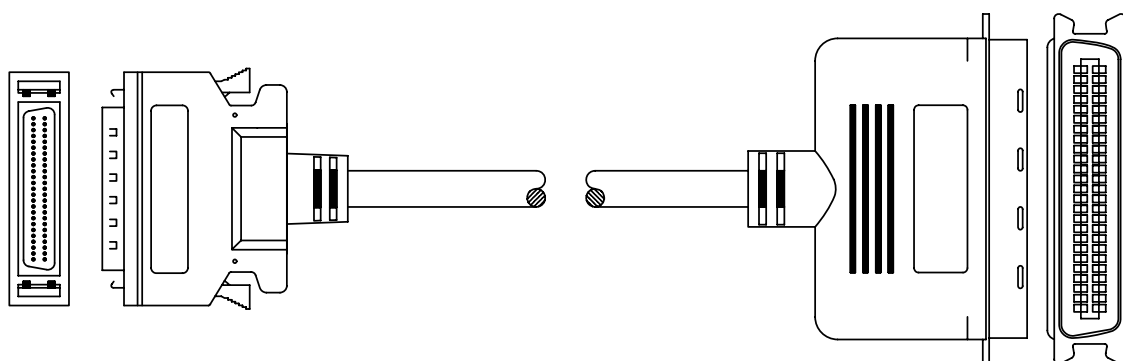

DB25 /M TO CEN.50/M

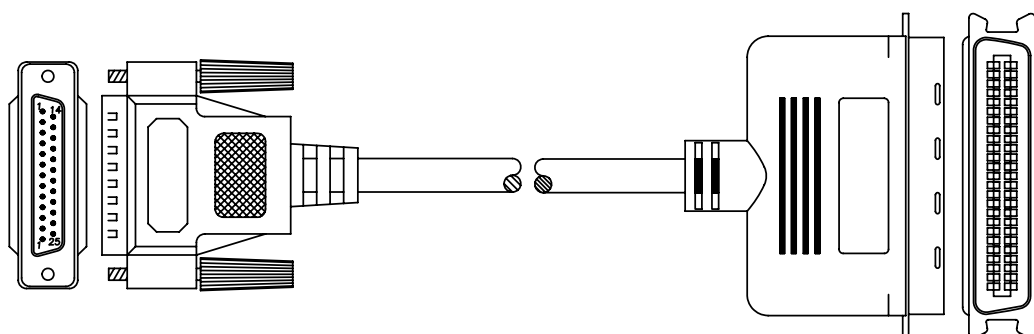

SCSI 68/M TO 68/M

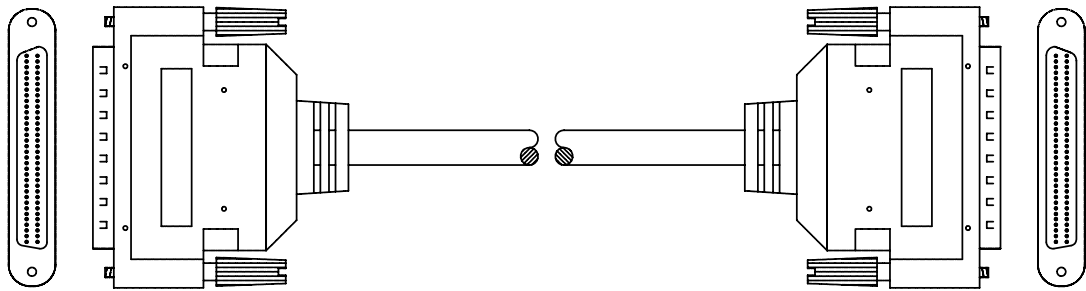

HP68/M TO HP68/M

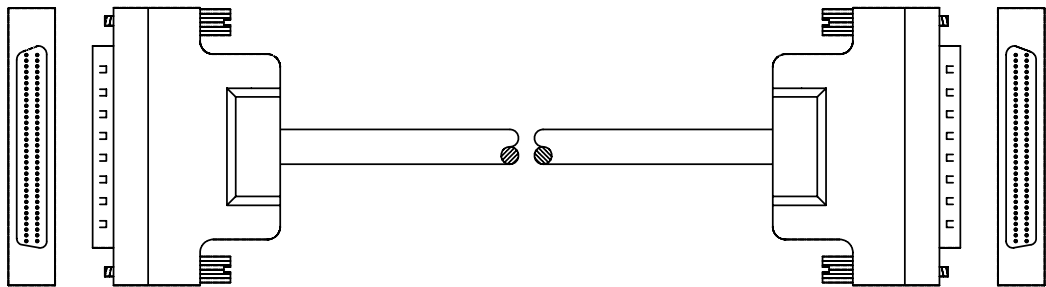

HP68/M TO HP68/M

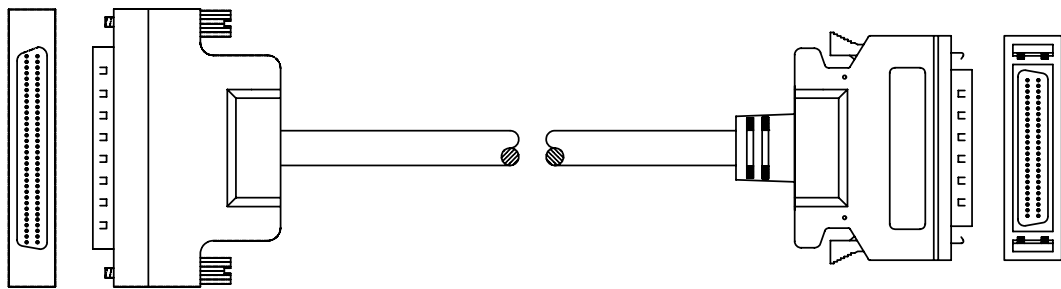

HP68/M TO HP68/M

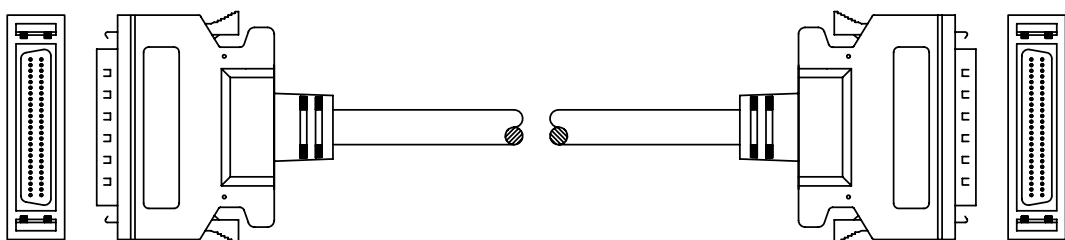

PITCH -0.8MM 50/M TO 50/M

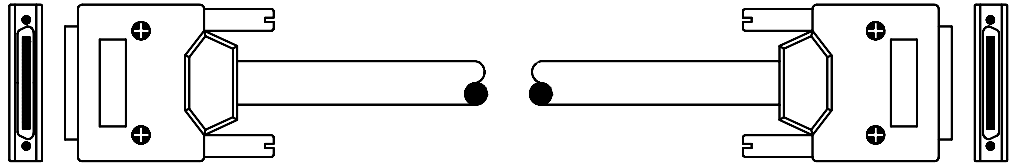

PITCH -0.8MM 50/M TO 68/M

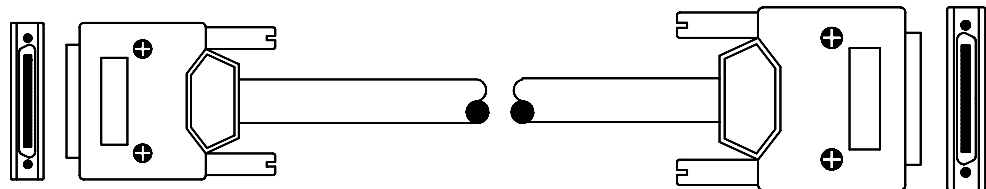

UNTRA SCSI 68/M TO 68/M

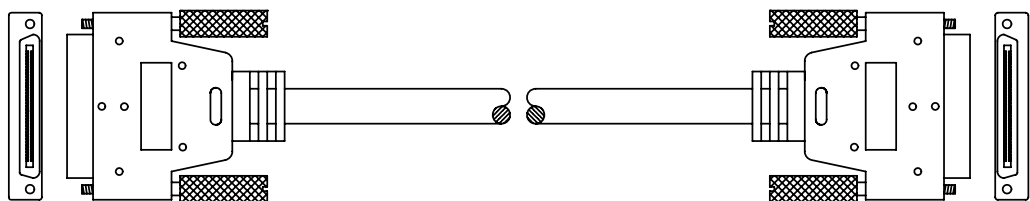

ULTRA SCSI 68/M TO CEN.50/M

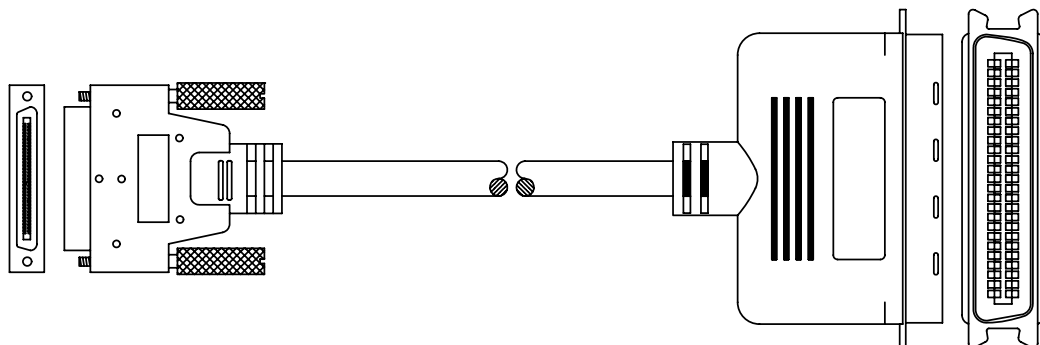

Nema5-15P to IEC Socket

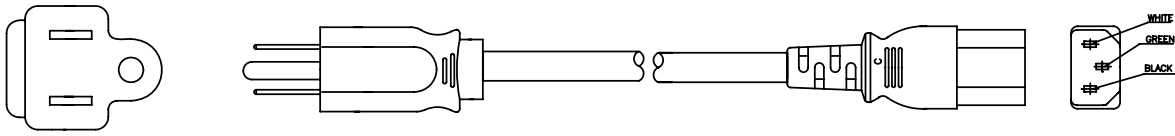

Nema 5-15P to Nema 5-15R

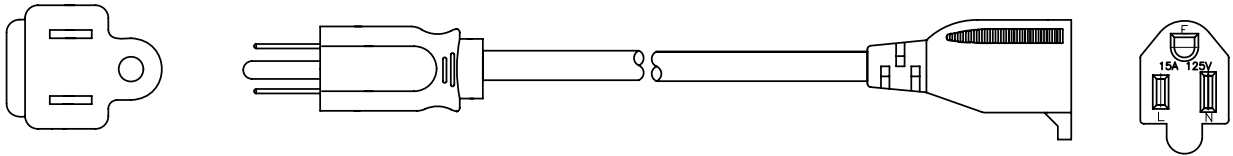

IEC SOCKET TO IEC PLUG

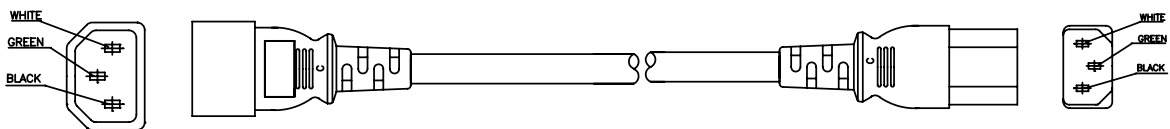

IEC PLUG TO NEMA 5-15R

